

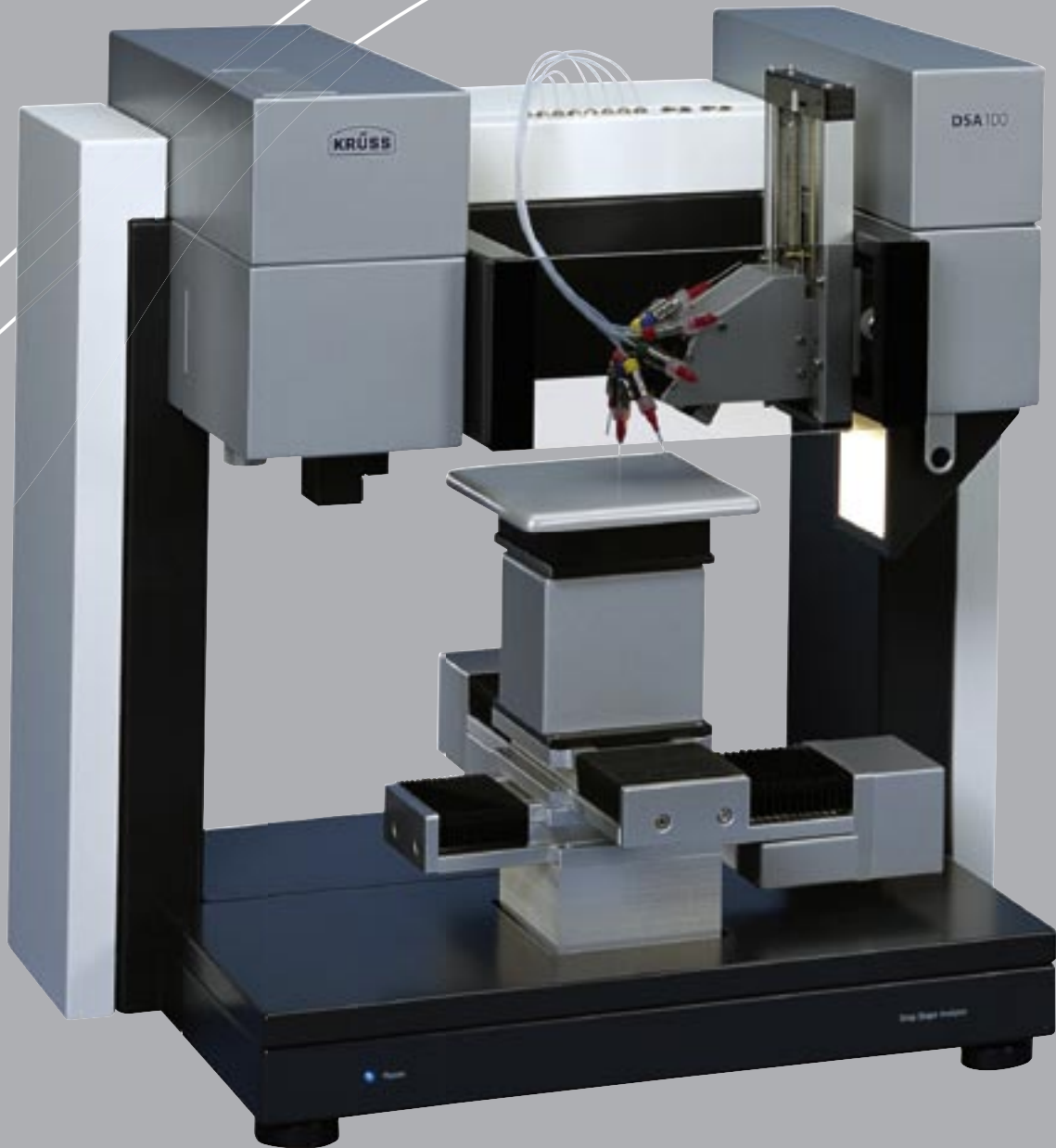

www.kruss.de

Drop Shape Analysis System DSA100

CUSTOM-MADE FLEXIBILITY



Advancing Surface Science

THE REVOLUTION IN CONTACT ANGLE MEASUREMENT

The DSA100 from KRÜSS

Uniquely versatile. The contact angle measuring instrument **DSA100** masters every measuring task, because KRÜSS GmbH has developed the concept of dual modularity for it: A comprehensive modular building block system with more than 30000 possible combinations ensures the flexible arrangement of sample size and measuring technique. In this way KRÜSS sets new standards for measuring contact angles.

TECHNICAL HIGHLIGHTS

- ▶ Optimal illumination with extremely low heat radiation
- ▶ New type of light guide eliminates all interference from stray light
- ▶ Unique adjustment of observation angle so that the drop is always in the center of the image
- ▶ Samples with an edge length of only a few μm up to LC displays can be measured
- ▶ Intelligent dosing system for quickly changing liquids without the risk of sample contamination
- ▶ Different axes and sample tables allow individual adaptation to a wide range of measuring tasks
- ▶ Vibration-inhibiting solid construction for sharp drop images
- ▶ Innovative software with predefined procedures

FEATURES

- ▶ Measurement of static and dynamic contact angles
- ▶ Measurement of surface free energy of solids
- ▶ Determination of polar and dispersive components, Lewis acid and base components, hydrogen bond forces
- ▶ Measurement of interfacial and surface tension of liquids
- ▶ Completely modular building block system
- ▶ Manual or automatic sample positioning
- ▶ Manual or automatic dosing of up to 8 test liquids
- ▶ Various temperature, high pressure and environmental chambers
- ▶ Wide range of dosing modules; also for nano- and picoliter dosing or for high temperatures
- ▶ EDM/ODM module (Expanding Drop Method/Oscillating Drop Method) for rheological interface experiments

APPLICATIONS

- ▶ Characterization of surface treatments
- ▶ Characterization of new surfaces
- ▶ Investigating adhesion properties
- ▶ Testing surface purity
- ▶ QC for wafers and microelectronics
- ▶ Measurement of the cleaning behaviour of surfactant solutions
- ▶ Characterization of the printability of surfaces
- ▶ Testing the wetting properties of plastics, glass or metal

DSA100: THE MODULES

As flexible as the demands placed on them

FRAME MODULES



AXES + SAMPLE STAGES

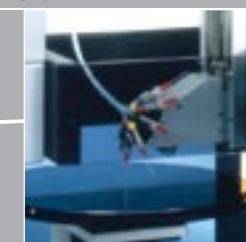

DOSING MODULES



MEASURING CHAMBERS

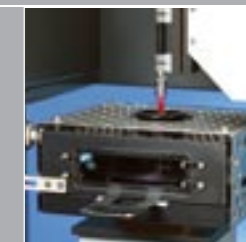

CAMERAS + ILLUMINATIONS



SOFTWARE

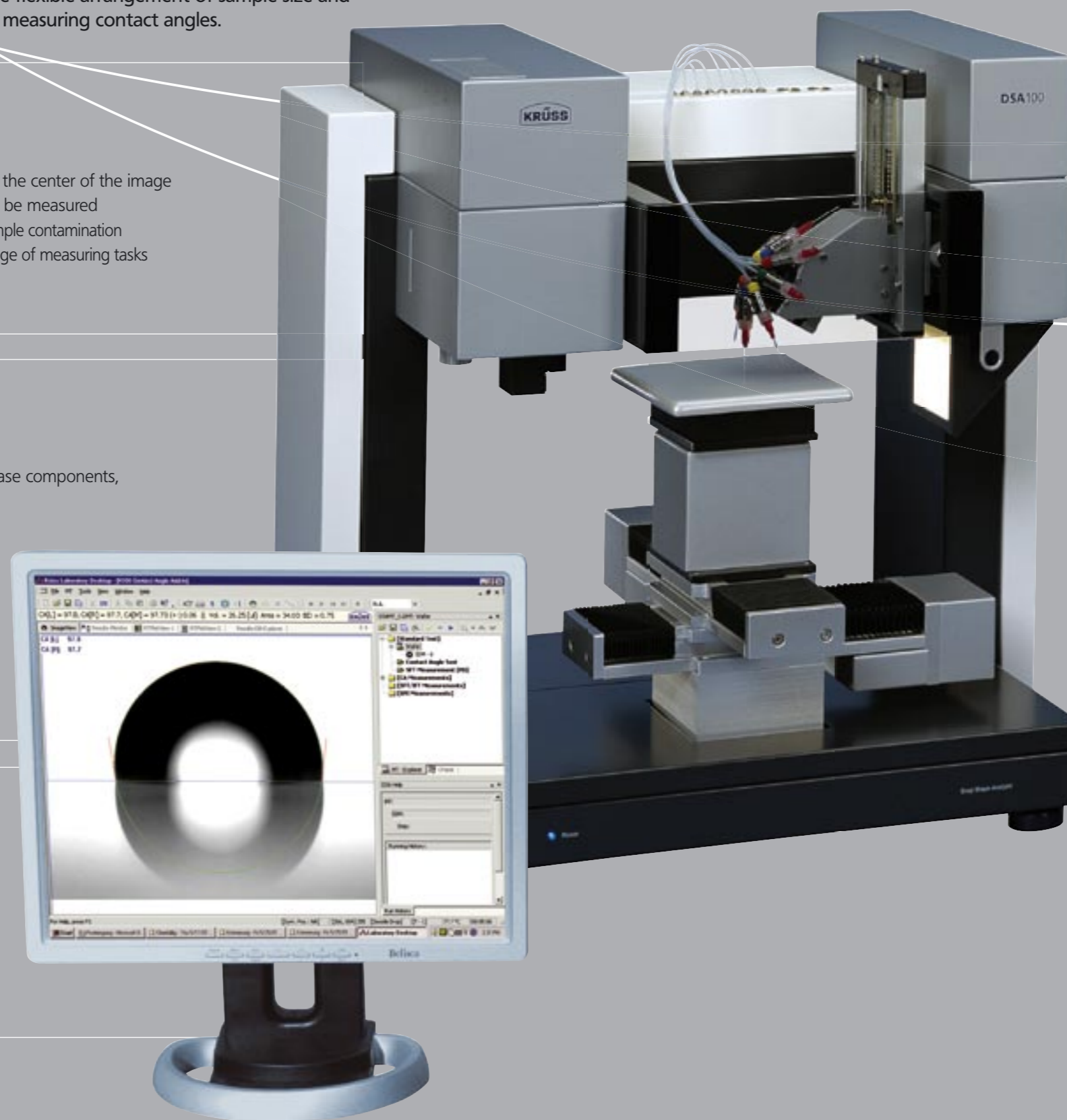
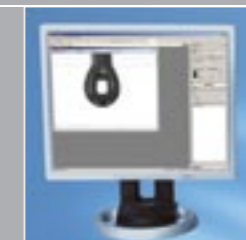



FRAME MODULES

Individual adaptation to all sample sizes

Standard Frame Module

Measurement in great style

No matter how large your sample: the frame modules of the **DSA100** meet all challenges. Even the standard frame module measures 12" (30 cm)-wafers and samples up to DIN A4 fully automatically. KRÜSS has developed a frame module for large samples such as wheel rims, bumpers or LC displays (see picture).

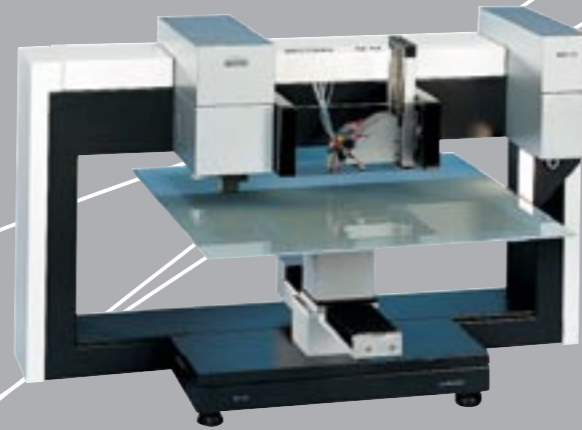

▶ Frame module for large samples

Tilting Table for DSA100

Maximum utilization of field of view up to 90°

With the tilting table for the **DSA100** you can tip each sample and the sessile drop positioned on it by up to 90°. Not only the sample is tilted, but the whole instrument. This arrangement ensures the maximum utilization of the field of view as the tilt angle increases, as the video camera and sample are always in the same plane. In combination with our high-speed cameras you can record the changes in the drop shape with up to 1000 individual images per second and more. Even at large tilt angles the tilting table provides the optimal solution for carrying out dynamic contact angle measurements.



▶ The drop shape analysis system from KRÜSS has proven itself in the automobile industry.

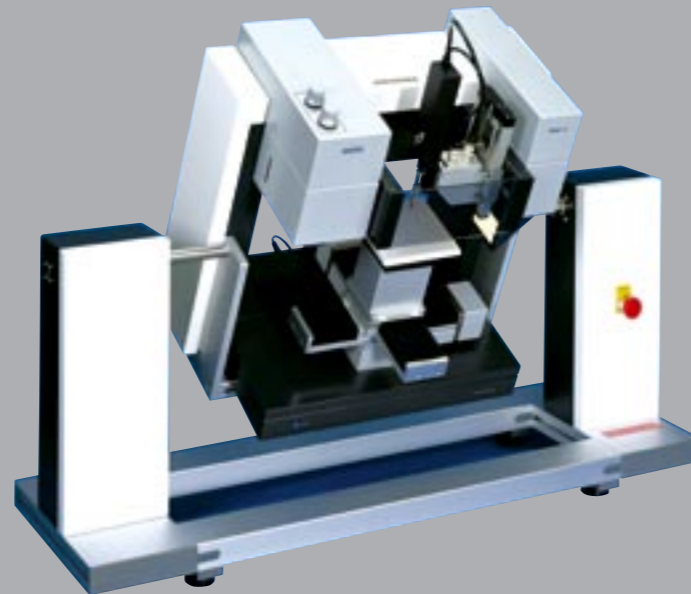

AXES AND SAMPLE STAGES

The pole position for your samples

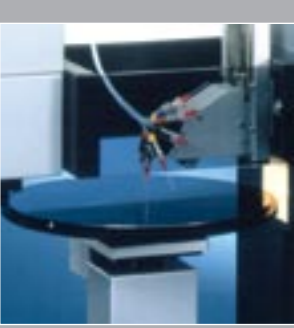

One for all: for virtually any sample size and shape the **DSA100** system offers an optimum sample table with suitable X-, Y-, and Z-axis lengths. You have the choice between manual or software-controlled measurements. The simple exchange of the axes and sample table makes the handling particularly user-friendly and allows adaptation to suit a wide range of samples such as wafers, tiles, very small electronic components or instrument panels.

Automatic Wafer Tester

Quality assurance as accurate as never before

The wafer tester in the **DSA100** series has been specially adapted to meet the high demands placed by quality control and development. The measuring system permits the rapid and exact determination of the contact angle as well as the surface free energy of silicon wafers. The handling robot removes the wafer from the connected cassette system and automatically transfers it to the **DSA100**. The fully modular system setup allows the simultaneous use of different cassette systems in a freely selectable arrangement.

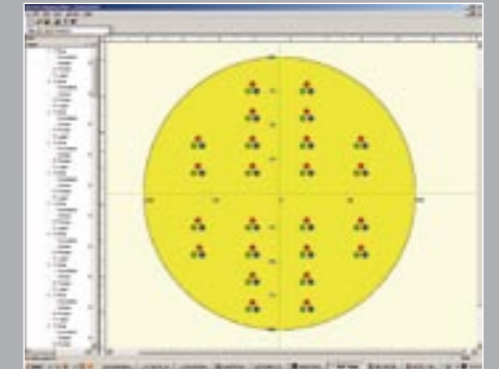

▶ Software control: Surface Mapping

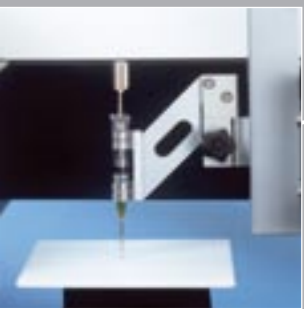

DOSING MODULES

The right solution for every measurement

Manual Direct Jet Dosing System DS3202

High-speed dosing

Save time: the DS3202 is the manual direct jet dosing system for reproducible volumes. Its strengths: rapid dosing, precision and reliability.

Multi-Dosing System with Software Control DS3228

The more the better

The DS3228 is very particular: the software-controlled multi-dosing system is suitable for measurements with up to 8 test liquids. This guarantees precise drop shape analyses, as the larger the number of test liquids used, the more accurate the calculation of the surface free energy and its components.

Direct Dosing System with Software Control DS3210

A quicker type of sample changing

The DS3210 does away with the meticulous cleaning processes that previously made measurements on paints, inks, adhesives and other liquid media so time-consuming. The direct dosing system works with glass syringes and disposable plastic syringes that are filled directly with the test liquid. This avoids the contamination of tubing and valves, while at the same time direct dosing permits particularly quick sample changing.

High Temperature Dosing System DO3241

Exact measurements up to 400 °C (752 °F)

The surface tension of high viscosity liquids and melts can be determined at temperatures up to 400 °C (752 °F). The combination of a high temperature dosing system and high temperature chamber is the optimum solution for contact angle and surface tension measurements above room temperature.

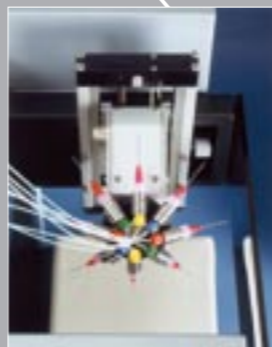
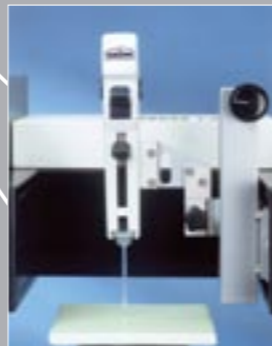

The Picoliter Dosing Systems

Great measurements on very small structures

The trend toward smaller structures in combination with constantly increasing demands on quality require new solutions for measuring contact angles. KRÜSS has met this challenge with the picoliter dosing systems: contact angle measurements on hairs, electronic components or print heads with up to 1000 measurements and more per second and drop volumes of 50 picoliters – no problem for the picoliter dosing systems from KRÜSS. The extremely high image recording rate in combination with the up to 50-times magnification of the drop image and special LED illumination with reduced thermal radiation guarantee the excellent image quality of the picoliter drops on very small structures.

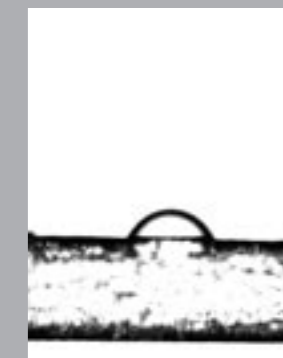
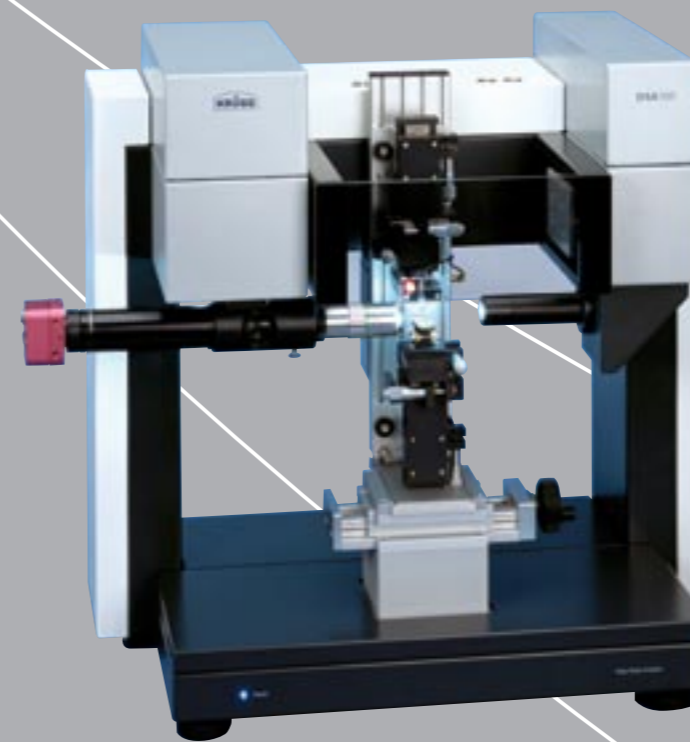

▶ Drop on hair

Cameras and Illuminations

Optimal optics

Keeping your measurements under observation: as an addition to the **DSA100** you can choose between standard cameras with 25 or 30 frames per second (fps) and high-speed cameras with recording rates of more than 1000 fps. The video cameras are protected against external influences by being enclosed in a housing. A cleverly devised mechanism permits adjustment of the angle of observation of the drop of liquid without altering its position relative to the optics. The current angle of observation is shown exactly by a laser diode.



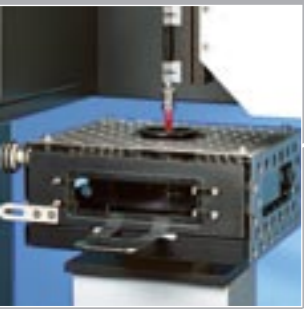

MEASURING CHAMBERS

For the highest thermostating demands

Peltier Temperature Chamber TC40

Modern measuring technology

With the temperature chamber TC40 KRÜSS has adapted thermo-electric heating technology for contact angle measurements. Its great strengths are the uniform temperature distribution within the chamber and rapid sample changing. In the range from -30 °C (-22 °F) up to +160 °C (320 °F) the Peltier elements quickly bring the sample to the required measuring temperature. By purging the sample chamber and the windows of the double-walled measuring cell with inert gas, condensation is prevented, even at very low temperatures. The inner of the two sample chambers can be accessed from outside, so that measurements can be carried out at different points on the sample surface. The TC40 sets new standards for modern and practical thermostating of contact angle measuring instruments.

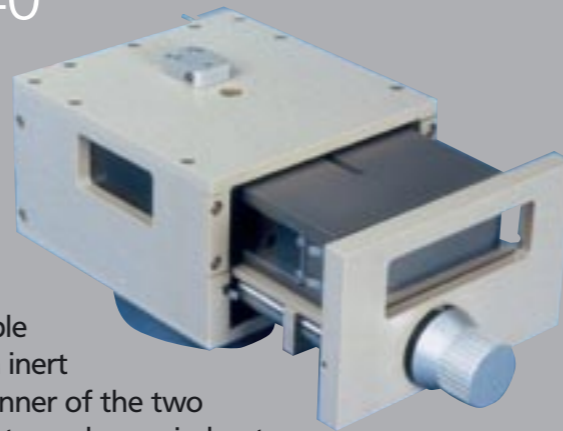

Temperature Chamber TC3010

Measuring at defined environmental conditions

The TC3010 has been specially developed for contact angle and surface tension measurements under defined environmental conditions. In combination with a laboratory thermostat the temperature can be controlled throughout a wide range. All measurements can be made in an inert gas atmosphere or under saturated water vapour. Temperature range: -10 °C (14 °F) to 120 °C (248 °F)

Temperature Chamber TC21

The specialist for high temperature measurements

If you want to measure at very high temperatures then you should use the TC21. The chamber has been specially developed for high temperature adhesives, metal alloys with low melting points and polymers. In combination with high temperature dosing system DO3241 contact angle measurements and measurements on pendant drops can be carried out up to a temperature of 400 °C (752 °F). Thermostating is carried out via an electronically controlled PID-controller; an additional temperature sensor in the sample chamber determines the exact sample temperature.

Temperature Chamber TC11

The ultimate for large samples

For handling large samples such as tiles the TC11 is the perfect solution. The key: within the measuring chamber the samples can be moved at right angles to the optical axis. This method ensures that measurements can be carried out at different positions on the sample surface, even in a sealed sample chamber. Temperature range: -10 °C (14 °F) to 120 °C (248 °F)

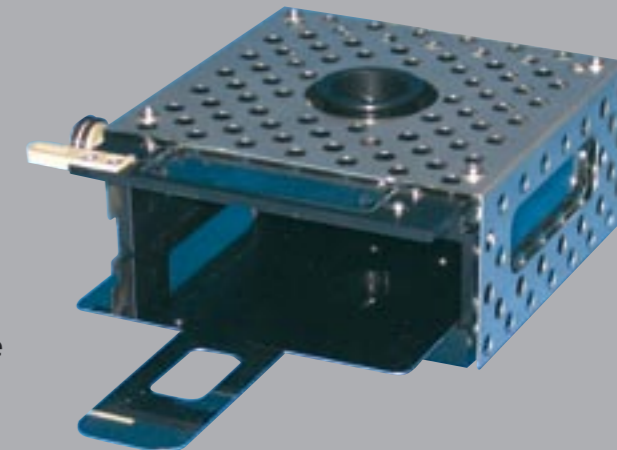

Humidity Control Unit HC10

Air conditioning for your samples

In combination with a temperature chamber the humidity control unit HC10 permits:

- ▶ Measurement of the contact angle as a function of the relative humidity
- ▶ Avoidance of changes in the relative humidity when the temperature changes

This new development makes it possible to independently control the temperature and humidity precisely throughout a wide range and to determine the influence of these quantities on the contact angle. Particularly important for long-term measurements: by keeping a constantly high relative humidity the evaporation of a drop of liquid can be minimized.

High Pressure Measuring Chambers

Facing up to extreme conditions

In combination with the Drop Shape Analysis System **DSA100**, the high pressure measuring chambers permit the determination of surface and interfacial tensions and contact angles in liquid-gas or liquid-liquid systems under extreme conditions. Maximum pressure: 69 MPa (10000 psi), maximum temperature: 250 °C (482 °F). Depending on the density ratio and technical factors, both pendant and sessile drops or bubbles can be generated and evaluated. In addition, the phenomenological observation of other substance properties such as phase transitions and swelling processes is possible.

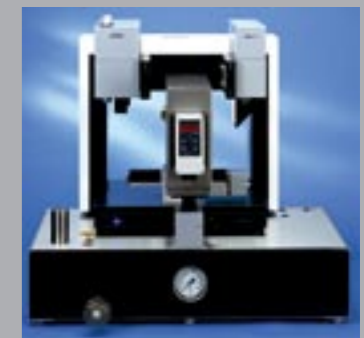



INTERFACIAL RHEOLOGY

EDM/ODM module: for the „expanding/oscillating“ drop method

Selective measurement of dynamic systems

The EDM/ODM module for the **DSA100** measuring system is the authority in the field of investigations into the interfacial rheological properties of surfactants.

Oscillating Drop Method, ODM Module Small drops with great effects

In addition to image analysis with Young-Laplace drop shape analysis for conventional measurements, KRÜSS has developed a new method: the measurement of the pressure curve by using small drops with a spherical surface. In this way the true dilatation behaviour during the expansion and contraction of the interface can be measured.

Advantages: considerably higher oscillation frequencies are possible compared with conventional image analysis. Liquid systems with similar or identical densities as well as high viscosity systems can be analyzed.

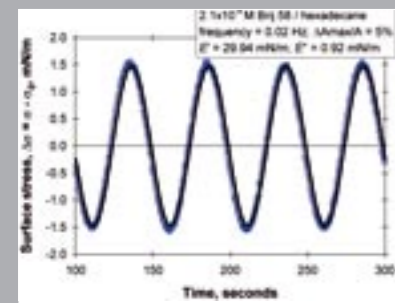

▶ ODM experiment (Brij 58)

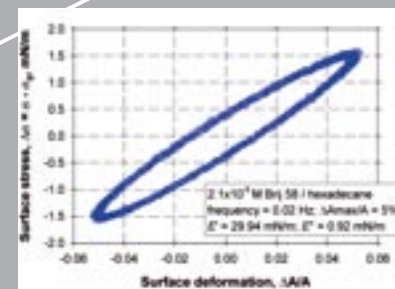

▶ The adsorption of Brij 58 takes place slowly. The modulus of elasticity is the same in both methods.

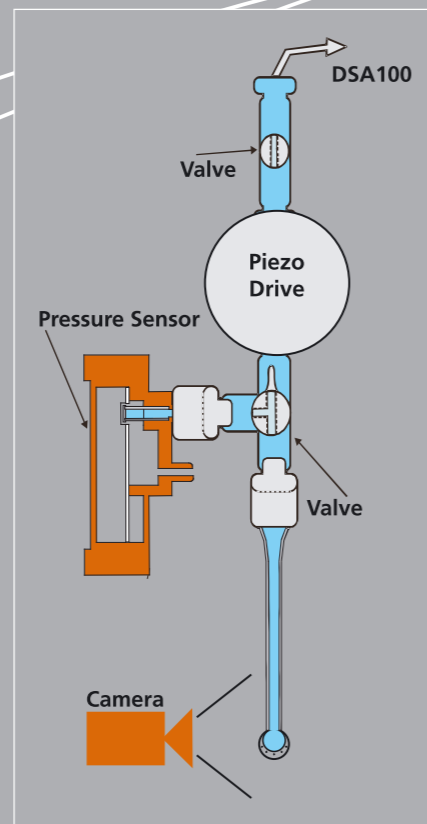

Expanding Drop Method, EDM Module Precision – drop for drop

The relaxation of the interfacial tension of a small spherical drop is measured after its spontaneous expansion or contraction. Deformation and deformation rate are uniform. This means that the actual dilatational viscosity can be determined.

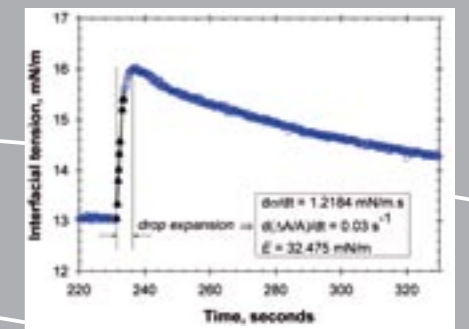

▶ EDM experiment (Brij 58)

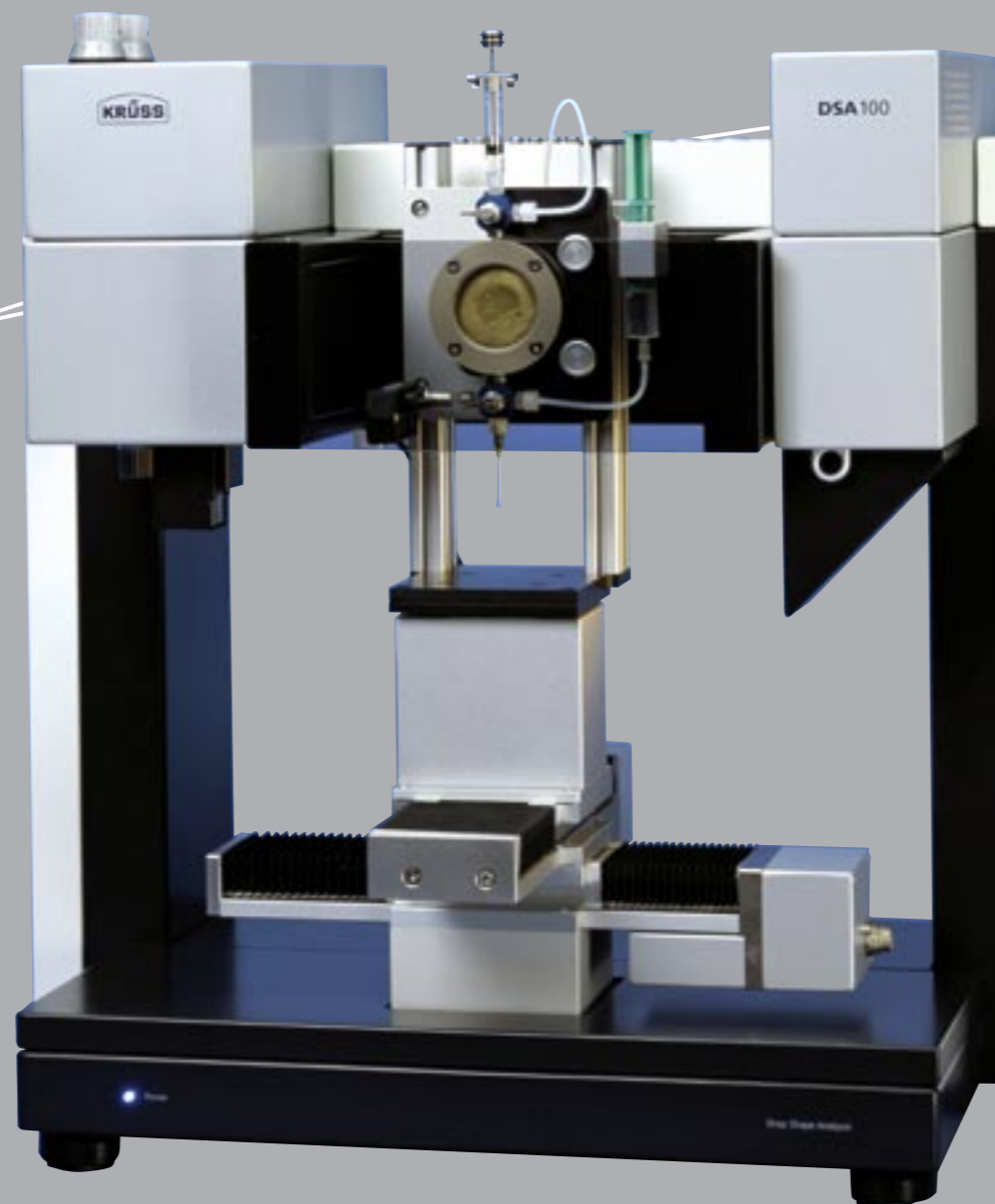

DSA100 with EDM/ODM Module: an overview

- ▶ Determination of the adsorption and relaxation behaviour of surfactants
- ▶ Investigation of the dilatational surface viscosity and elasticity
- ▶ Capillary pressure measurement and drop shape analysis as alternative measuring methods
- ▶ Measurements on liquids with similar or identical densities and at high viscosities
- ▶ Quick and simple calibration using a reference liquid
- ▶ Fully compatible with the modular structure of the **DSA100**



SOFTWARE DSA3

Most up-to-date measurement control

All instruments in the modular **DSA100** series are controlled by the drop shape analysis software DSA3. Definition of the measuring task is extremely flexible and leaves nothing to be desired.

- ▶ DSA3 is plug&play. The software automatically recognizes all modules of the **DSA100**, such as dosing systems, axes, sample stages, optics and illumination systems, as well as additional components such as tilting tables and temperature chambers.
- ▶ DSA3 has one of the most modern and easy-to-use integrated graphics user interfaces for data acquisition and the evaluation and management of drop shape images.
- ▶ The operating concept is based on templates ("Measurement Templates") that only have to be adapted to the particular measuring task. This means that highly efficient work is possible with the **DSA100**. The menu-guided, sequential generation of the "Measurement Templates" with a "Wizard" permits the simple and rapid solution of measuring problems.
- ▶ All measured values can be shown in real time, both graphically and in tabular form, on the "Results Database Monitor". Video recordings of very dynamic processes with subsequent evaluation are also possible, as is the loading and evaluation of images.

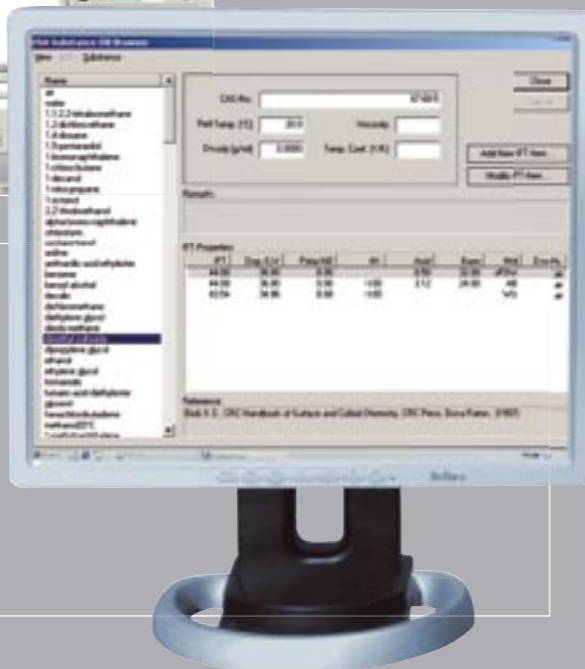
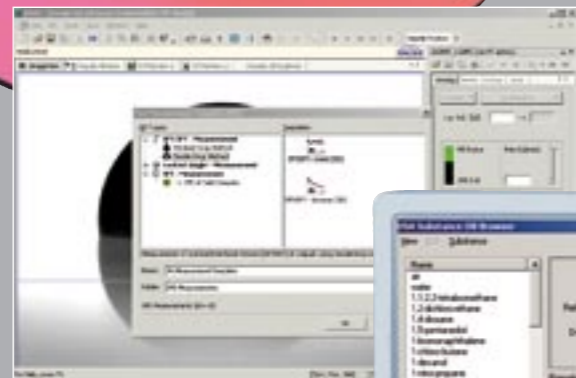
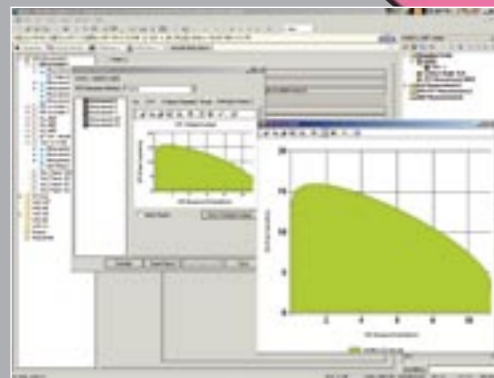
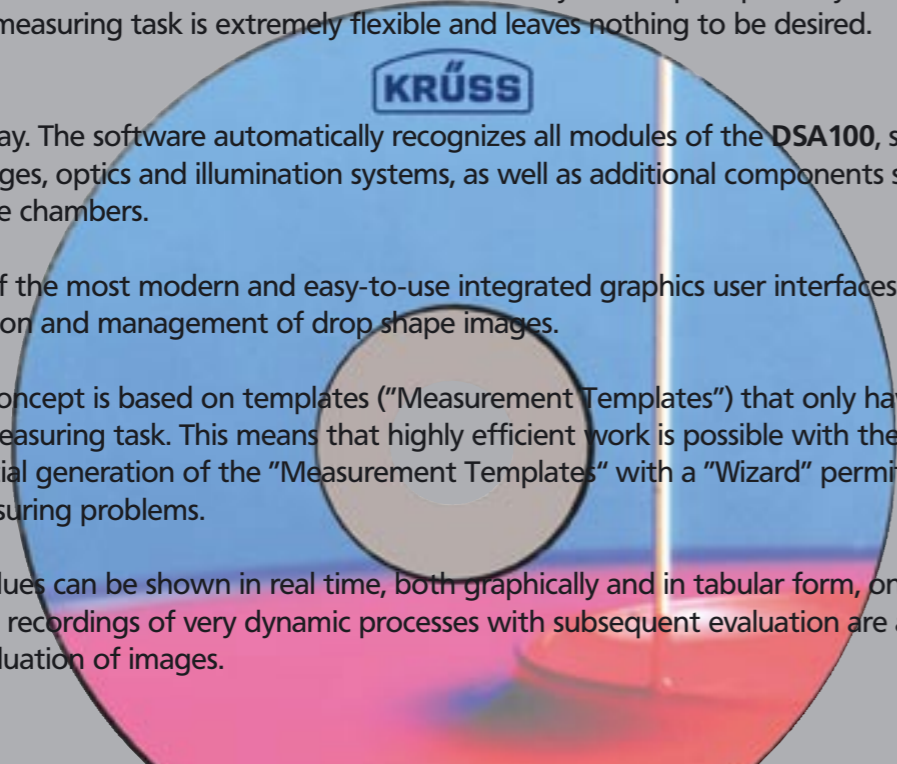

Databases

A comprehensive gases, liquids and solids database contains a vast amount of substance data. This data can be transferred to the corresponding input field with a mouse click for the definition of a new measurement. Reference sources are given for all the substance data, so that you yourself can check the quality of the data. All databases can be edited. You can add further data records at any time.

- ▶ The measurements can be carried out completely automatically, as a graphical mapping module is available for defining the measuring points on the sample surface.
- ▶ All measured values, plots and reports are stored in the "Results Database Explorer". In this clearly laid-out database you can conveniently process all your data. The presentation of all plots is fully configurable, also in 3-D. A powerful, flexible report module allows reports based on individual templates to be drawn up.
- ▶ Comprehensive export facilities are available for problem-free further processing of your data: Microsoft™ Excel, RTF, PDF, HTML, BMP, TIFF, JPG. DSA3 runs under all operating systems from Windows 2000 onward.

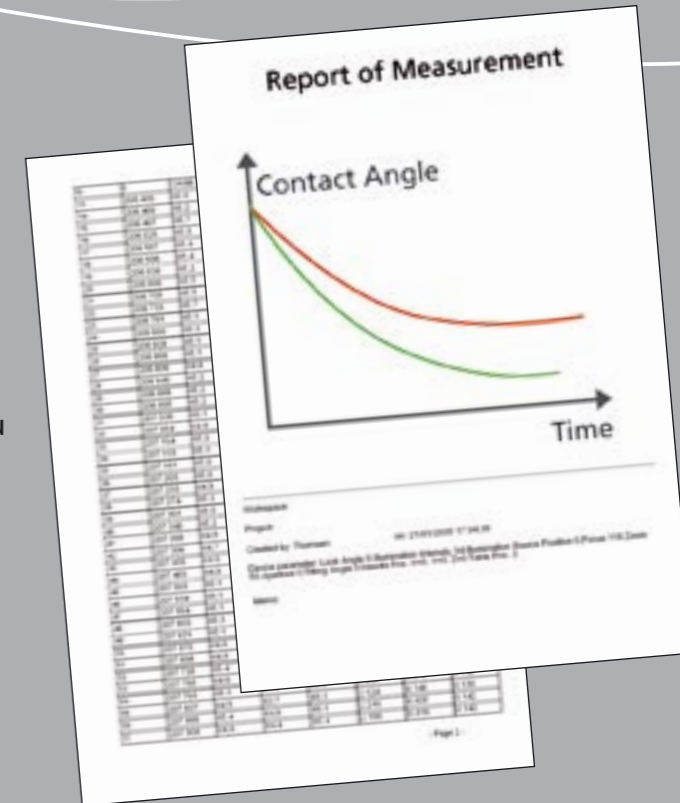

DSA3 Software Packages

You can select the most suitable software package for your particular application:

▶ Contact Angle

Optical contact angle measurement for the determination of the wetting behaviour at any point on a solid surface by the sessile drop method. Various models are available for the optimal measurement of the dynamic and static contact angle, as well as for drop shape fitting.



▶ Surface Free Energy

Module for the determination of the surface free energy by measuring the contact angle using different liquids. Numerous models are available. The "Wetting Envelope" option will calculate the polar and disperse components that a liquid must have in order to completely wet a particular solid. These components are shown as a graph.



▶ Pendant Drop

Suitable for interfacial and surface tension measurements on pendant or ascending drops. Measurements are also possible under extreme pressures and temperatures by optically measuring the drop shape in closed systems.





DSA100: MEASURING METHODS

Precision comes from diversity

The possible applications are just as versatile as the modular building block system of the DSA100. The table below provides an overview of these measuring methods:

Methods:

▶ Sessile Drops

The standard method for quick and accurate wetting tests. The deposited drop lies on the surface and forms a contact angle that depends on the properties of the three phases: drop liquid, solid and surrounding phase.

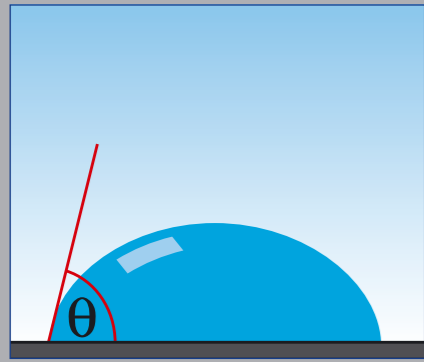

▶ Advancing Angle

Dynamic contact angle on a constantly increasing drop. The wetting line is always fresh. Alterations due to time-based effects are eliminated.

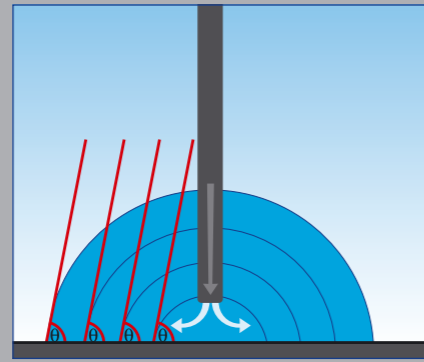

▶ Receding Angle

This is the opposite of the advancing angle. The dewetting properties of the solid are studied.

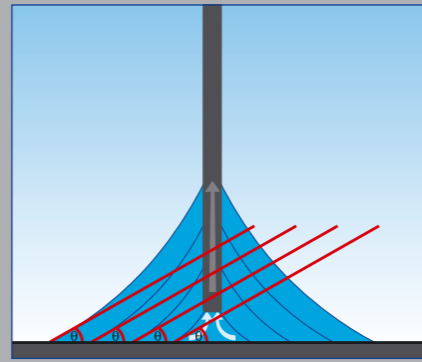

▶ Captive Bubble

For contact angles beneath a solid surface. The contact angle of a gas bubble or low density liquid surrounded by a higher density liquid beneath the surface is measured.

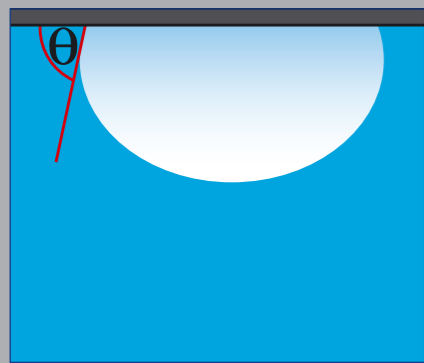

▶ Dynamic Contact Angle

How does the drop become deformed when the surface is tilted? The tilting table method provides the answer to this question. It also allows conclusions to be made about the roughness and rolling resistance properties.

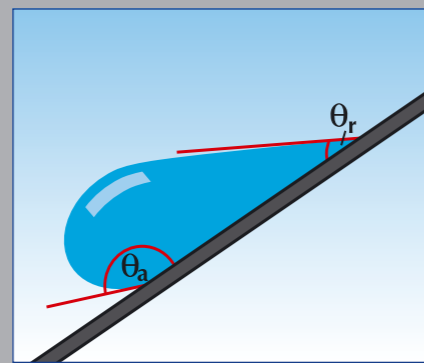

▶ Pendant Drop

The optimum completion to contact angle measurements. The shape of a pendant drop reveals the surface tension of the liquid – thanks to Young-Laplace.

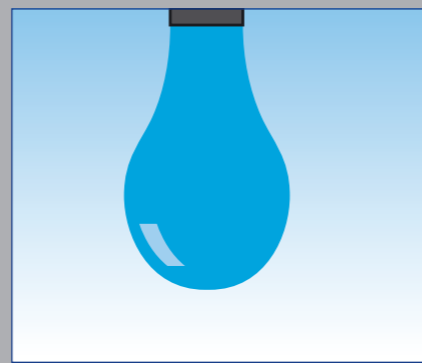

Evaluations:

▶ Surface Free Energy

From measured contact angle data it's possible to calculate the surface free energy of the solid by various methods. Division into polar and disperse components, acidic, basic components and the component resulting from hydrogen bridge bonds is carried out by pressing a key.

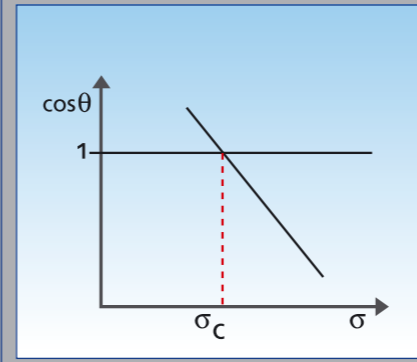

▶ Wetting Envelope

A graphical method for the surface free energy that provides a quick overview of the wettability of solids. All liquid with data in a particular range will wet the solid completely.

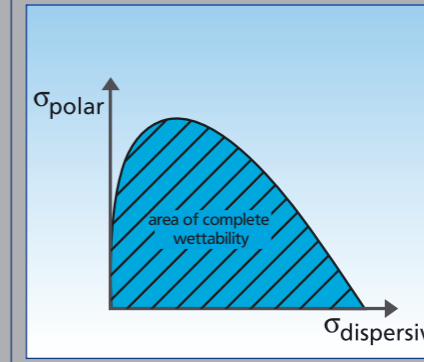

▶ Surface Mapping

How homogeneous is the solid surface? Mapping generates a "map" of the solid surface – the surface free energy is measured as a function of the position on the surface.

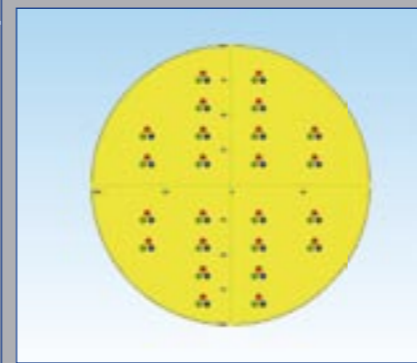

▶ Hysteresis

Comparison between the advancing and receding angles. The difference, known as hysteresis, permits statements to be made about surface roughness. The contact angle is plotted against the volume deposited.

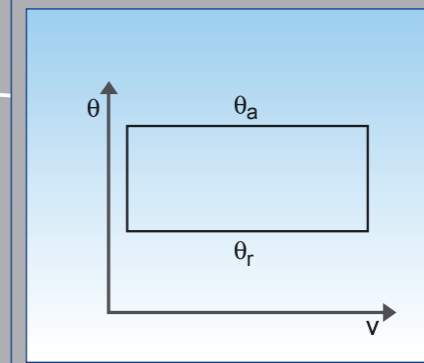

COSE

YOUR DISTRIBUTOR:

Visit our website at:

www.kruss.de

Advancing Surface Science



KRÜSS GmbH
Wissenschaftliche Laborgeräte
Borsteler Chaussee 85-99a
D-22453 Hamburg
Tel.: +49 – 40 – 51 44 01-0
Fax: +49 – 40 – 51 44 01-98
E-Mail: info@kruss.de

KRÜSS GmbH
38/40 Avenue Jean Jaurès
F-91120 Palaiseau
Tel.: +33 – 1 – 60 14 94 94
Fax: +33 – 1 – 60 14 95 48
E-Mail: info@kruss.fr

KRÜSS USA
1020 Crews Road, Suite K
Matthews, NC 28105

Tel.: +1 – 704 – 847 8933
Fax: +1 – 704 – 847 9416
E-Mail: info@kruss-usa.com